

LT-702-CC 1-10V LED Dimming Driver (CC Type)



LTECH developed a new 0/1-10V to PWM dimming driver which has solved the compatible problem of the fluorescent dimming system and the LED illumination. LED lamps can be controlled by many traditional intelligent dimming systems such as Lutron, Dyalite, Tridonic, Schneider, Clipsal, Osram, Philips, ABB, etc.

LT-702-CC is compatible with the active/passive 0-10V, 1-10V, 10VPWM and the PUSH BUTTON insert dimming, optional with 3 in 1 current 1400mA/1750mA/2100mA, Wide range support 4.2W~96.6W LED connection and ensure accurate current output automatically. With above advantage, one LT-702-CC could be the substitute of more than 10 models in the same kind, make it much more convenient for sales and installations.

LT-702-CC, 0-100% PWM dimming, output with the dimming curve that is more palatable to human vision, provide the user with more comfortable and natural lighting experience.

* By working with our LT-701-10A/LT-701-CC 1-10V dimming driver, the basic issue that related LED projects and needs 1-10V dimming can be solved.

1. Product Parameter:

LT-702-CC

- Input signal: 0-10V, 1-10V, 10V PWM, resistor or push button
- Output power: 4.2W~96.6W
- Power Supply Chosen: DC CV SMPS
- Working Temp.: -30°C~55°C
- Input voltage: DC12V~DC48V
- Dimension: L175×W44×H30mm
- Output voltage: DC3V~DC46V
- Package Size: L178×W48×H33mm
- Output current: CC 1400/1750/2100mA 3 in 1 ×1CH
- Weight (G.W): 125g

2. Product Dimension:

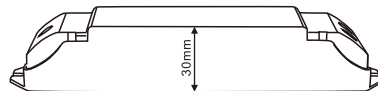
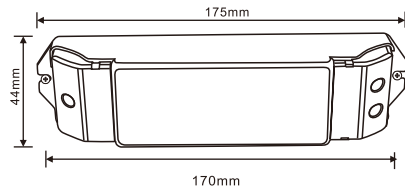

1

3. Terminal Description:

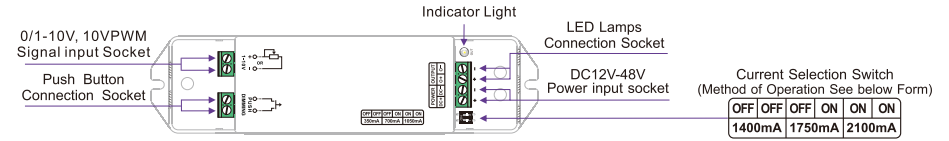

4. Conjunction Diagram:

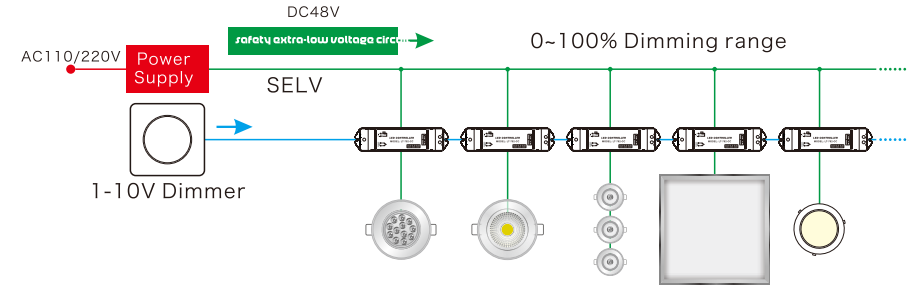

1. Connection Diagram for High Power LED :

variety of flexible connection, convenient for installation, for example:

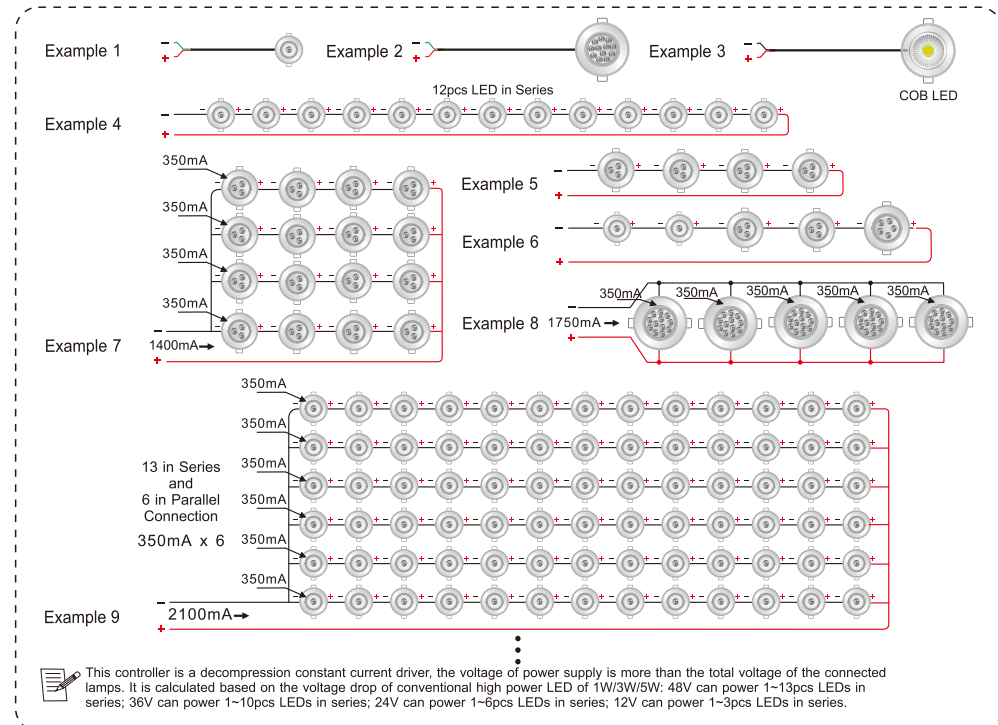

This controller is a decompression constant current driver, the voltage of power supply is more than the total voltage of the connected lamps. It is calculated based on the voltage drop of conventional high power LED of 1W/3W/5W: 48V can power 1~13pcs LEDs in series; 36V can power 1~10pcs LEDs in series; 24V can power 1~6pcs LEDs in series; 12V can power 1~3pcs LEDs in series.

2

2. Connection Diagram for Low Power LED 5050,3528:

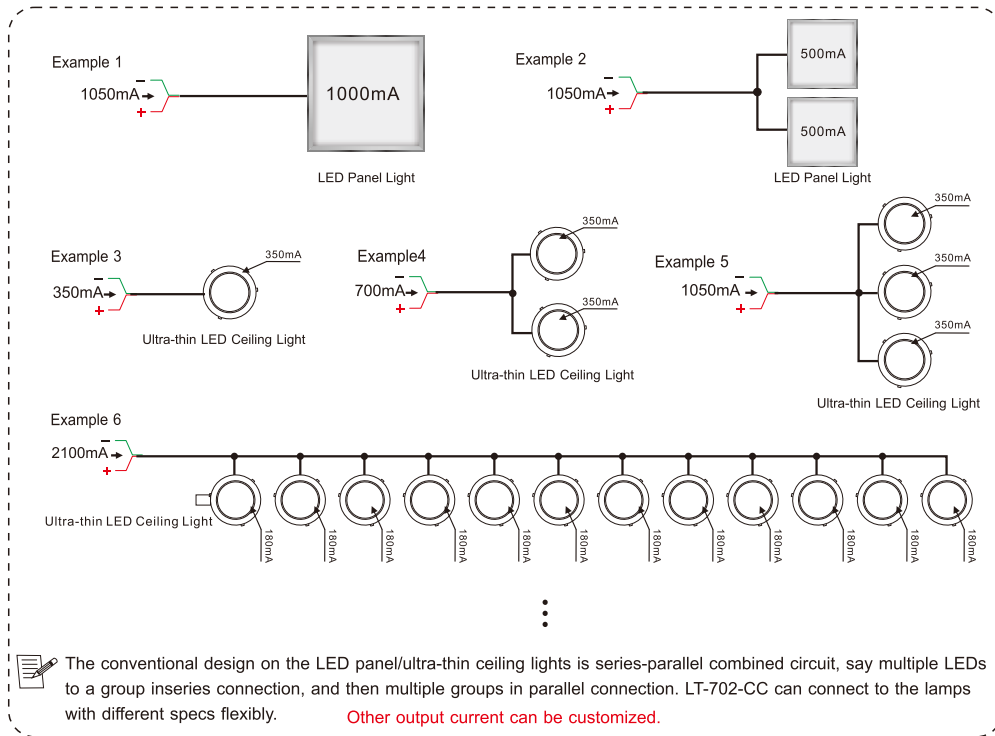

3. System Connection Diagram:

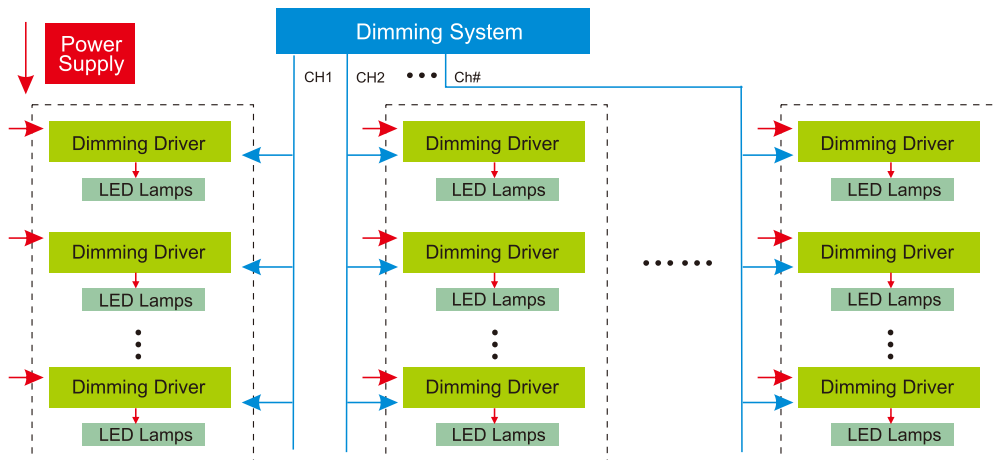

5. Attention:

- 1) The product shall be installed and serviced by a qualified person.
- 2) This product is non-waterproof. Please avoid the sun and rain. When installed outdoors please ensure it is mounted in a water proof enclosure.
- 3) Good heat dissipation will prolong the working life of the controller. Please ensure good ventilation.
- 4) Please check if the output voltage of any LED power supplies used comply with the working voltage of the product.
- 5) Please ensure that adequate sized cable is used from the controller to the LED lights to carry the current. Please also ensure that the cable is secured tightly in the connector.
- 6) Ensure all wire connections and polarities are correct before applying power to avoid any damages to the LED lights.
- 7) If a fault occurs please return the product to your supplier. Do not attempt to fix this product by yourself.

6. Warranty Agreement:

- 1) We provide lifelong technical assistance with this product:
 - A 5-years warranty is given from the date of purchase. The warranty is for free repair or replacement and covers manufacturing faults only.
 - For faults beyond the 5-years warranty we reserve the right to charge for time and parts.
 - 2) Warranty exclusions below:
 - Any man-made damages caused from improper operation, or connecting to excess voltage and overloading.
 - The product appears to have excessive physical damage.
 - Damage due to natural disasters and force majeure.
 - Warranty label, fragile label and unique barcode label have been damaged.
 - The product has been replaced by a brand new product.
 - 3) Repair or replacement as provided under this warranty is the exclusive remedy to the customer. LTECH shall not be liable for any incidental or consequential damages for breach of any stipulation in this warranty.
 - 4) Any amendment or adjustment to this warranty must be approved in writing by LTECH only.
- ★This manual only applies to this model. LTECH reserves the right to make changes without prior notice.