

LTECH

LT-600
LED Lighting Control System



FC **CE** **RoHS** **5-Year Warranty**

LT-600 lighting control system is our latest launch of a world's advanced LED lighting products video display control system. LT-600 kernel is VLSI. It can achieve computer's simultaneously play, offline video on demand, WiFi wireless transmission, automatic timing control and its exterior connect with DMX console to reach the world's first 5 in 1 function. Achieving synchronization/offline seamlessly switch, no need any splitter. Online control doesn't need to add DVI display adapter and send cards, easy to install, matching software's function perfect. Easy to operate. Compatible with a variety of LED driving IC; break through traditional rule of cabling restrictions, support a variety of any cabling's abnormal lighting project, make the controlling cabling more flexible, apply to any indoor or outdoor LED lights online / offline control. Advanced color grey level processing technology, consistent with human eye's visual sensory, display effect will be more vivid, higher brightness, richer color. Let your LED lights effect performance thoroughly, one-upmanship!

1. Specifications:

LT-600 LED Lighting Control System

Working voltage:	12Vdc (with a power supply adapter)
Output signal channels:	16 channels
SPI output:	Max 1364 pixel×16CH 21824 pixel
DMX output:	Max 170 pixel×16CH 2720 pixel
Input & output interface:	RJ45
Grey level:	Max 65536 scale (64K)
Refreshing frequency:	60Hz~3000Hz
Online transmission mode:	TCP/IP standard internet protocol
Off-line storage media:	SD memory card
SD card capability:	Max. 2GB
The 3th interface:	DMX512/1990 Protocol
Operating system:	Support Chinese and English Windows 2000/2003/XP/Vista/Windows 7/10
Product size:	L203×W125×H47[mm]
Packing size:	L267×W138×H88[mm]
Weight:	920g(N.W.) 1450g(G.W.)

2. Features:

- 2.1 One set controller collect 5 kinds major function, which reached by previous multiple controllers.
- Ethernet real time computer control via synchronous display, supporting WiFi wireless transmission.
 - Offline play stored programme in SD card, stored programme, speed chosen and other functions will be seen with half an eye on the LCD.
 - Compatible with DMX protocol, connecting DMX console to build lighting control network.
 - Support WiFi wireless transmission, suitable for special occasion, no wiring needed.
 - Supporting timing display. Realize display different programs, no matter on working day or weekend.

- 2.2 Output DMX signal directly, and controlling various LED driving chips, The LED lights base on the following IC can be controlled: 74HC595, 6B595, MBI5026, DM134, ZQ9712, LPD6803, LPD6813, LPD1101, D705, UCS6909, UCS6912, UCS1903, UCS1909, UCS1912, UCS2903, UCS2909, UCS2912, WS2801, WS2803, WS2811, WS2812, WS2812b, HL1609, SM16716, SD600, P9813, LPD8803, LPD8806, LPD8809, LPD8812, TLS3001, TLS3002, TLS3003, TM1803, TM1804, TM1809, TM1812 etc..
- 2.3 LED lights not only in accordance with the rule of cabling, but also support a variety of any cabling's abnormal lighting project, easy to operate via setting software.
- 2.4 Extra large control capability, 16 channels signal output, Max. control 32768 full color pixels per LT-600. Support network synchronization of multiple controllers, multiple networked can control max. 250,000 full-color pixels.
- 2.5 On-line controlling adopt universal 10/100/1000MBPS network interface, with TCP/IP standard Ethernet protocol, accommodate to wide range. Reliable communication, support WiFi wireless network transmission and real-time simultaneous display.
- 2.6 Adopting advanced image processing technology. Online synchronous play doesn't need to add DVI display adapter or send card, any desktop and laptop can control it, convenient for project's debugging and demonstration.
- 2.7 Adopting the way of network synchronization, synchronous controlling of multiple can be achieved through network switch. The transmission distance will be unlimited.
- 2.8 Animation, video files converted generate ultra-fidelity off SD card's read files. ultra-small size, let the time of request programmes longer. And the content more affluent, SD card is easy to play the animation, either pull down and then use card reader to update, can also be updated remotely via Ethernet.
- 2.9 Advanced color grey level processing technology, consistent with human eye's visual sensory, display effect will more vivid, higher brightness, richer color. Effectively remove the tooth angle produced by the floating line in video, show the smooth and natural image.
- 2.10 Perfect software function, simple to operate, built-in video player, support most media format. User can compile various picture, texts, cartoon, video as programmes that will be present. Can input any text display in the process of play. Support viewfinder read the display on screen directly. Breakthroughing the restrictions to code stream format, play format file at will. Achieve split screen display, can divide screen at will. Switching Chinese and English version freely.

3. Spare Parts:

- | | |
|---------------------------|--------|
| 1. Network cable | 2 pcs |
| 2. Signal cable converter | 16 pcs |
| 3. Power supply adapter | 1 pcs |
| 4. SD memory card | 1 pcs |
| 5. SD card reader | 1 pcs |



Network cable



Signal cable converter



Power supply adapter



SD memory card



SD card reader

4. Product Diagram:

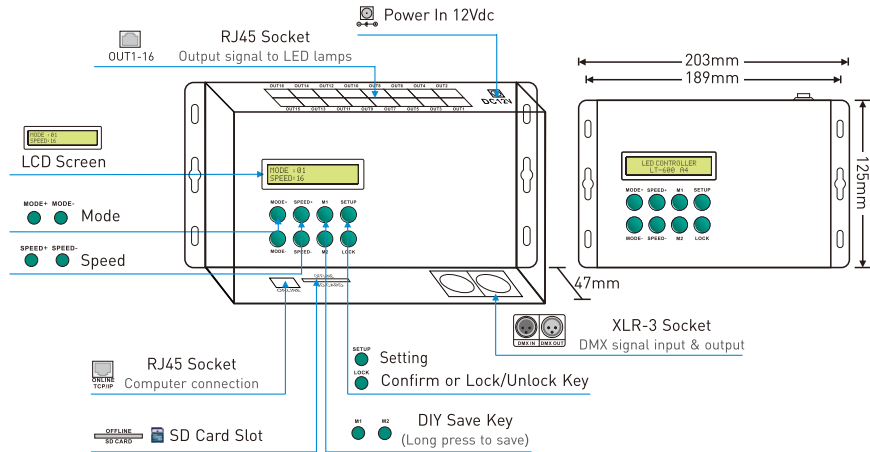

5. Offline Operating Instructions:

There are 8 function keys on the controller: MODE+/MODE-, SPEED+/SPEED-, M1/M2, SETUP, LOCK

5.1 Press MODE+/MODE- to switch:

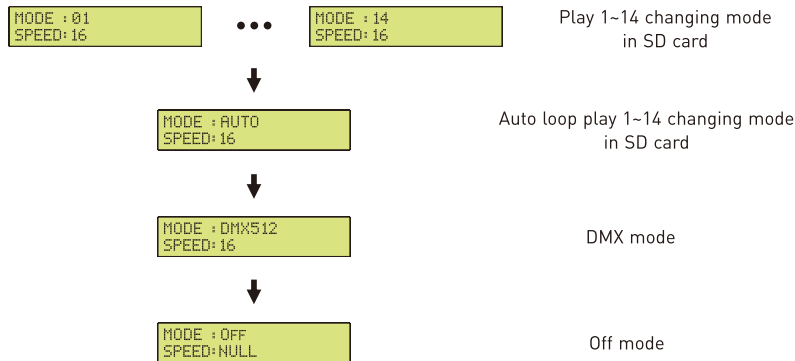

5.2 Long press LOCK key to lock/unlock the keypad:



5.3 Press SETUP key to setup DMX address:

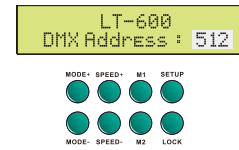

Press MODE+/- to adjust the hundred numbers.
Press SPEED+/- to adjust the ten digit numbers.
Press M1/M2 to adjust the single digit numbers.
Press LOCK to confirm.

6. Signal Cable Definition:

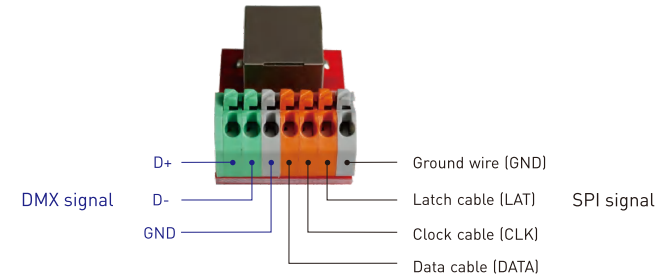

7. Compatible with Various IC:

Connection	Signal cable	Support IC Model	Software IC Option
<p>2 cables DATA GND</p>		TM1803, TM1804, TM1809, TM1812, UCS1903, UCS1909, UCS1912, UCS2903, UCS2909, UCS2912, WS2811, WS2812, WS2812B, GS8206(BGR), SM16703	1804/1812
		TLS3001, TLS3002, TLS3003	3001/3002
<p>3 cables DATA CLK GND</p>		LPD6803, LPD1101, D705, UCS6909, UCS6912	6803/D705
		WS2801, WS2803	2801/2803
		SD600	SD600
		P9813	P9813
<p>4 cables DATA CLK LAT GND</p>		SM16716	16716
		LPD8803, LPD8806, LPD8809, LPD8812, LPD6813	8803/8806
<p>4 cables DATA CLK LAT GND</p>		74HC595, 6B595, MBI5026, DM134, ZQ9712	RGB
<p>3 cables D+ D- GND</p>		DMX512/1990	DMX512

8. Install and Uninstall the Software:

8.1 System Requirements

System Versions: □ Chinese/English Windows 2000/2003/XP/Vista/Win7/Win 10.
Interface type: RJ45 Ethernet interface.



8.2 Software Installation

Please use the incidental SD card reader in the product packing box to read the installation file "LED-Player_V7.4.exe". Double click to run and installation according to the hint.

LED_Player_V7.4.exe

8.3 Software Uninstall

Uninstall the software with the operating system's uninstall function, or with the direct uninstall program of the operating system.

8.4 Software Running

Double click to the generated shortcut:



Software running interface as right, the interface can be displayed or hidden.



Software running interface

9. How to Use The Software:

Attn: Please connect the LT-600 controller with computer directly or through a switch/router.

9.1 Parameter Setting:

9.1.1 Search controller

Click [Control] menu and select [Settings], then click [Search] on the pop-up interface to search the connected LT-600 controller list.

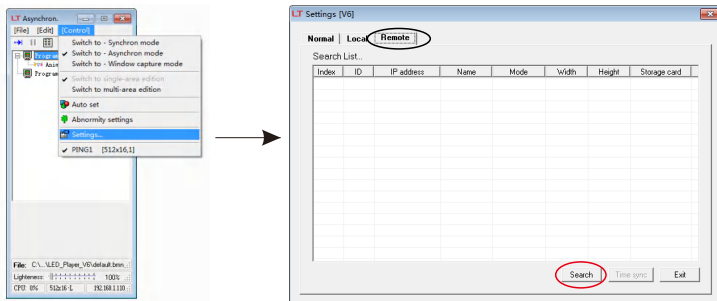

9.1.2 Enter the main interface of setting

Double click the LT-600 controller to be controlled, enter "led888" as password to the main interface of setting.

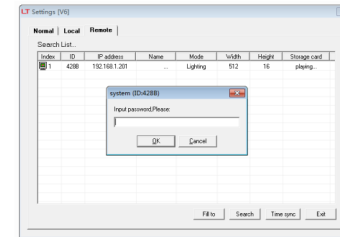

Password input dialog box

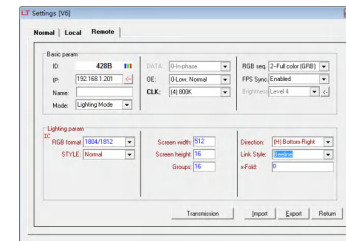

Main interface of setting

9.1.3 Setting parameters

Set parameters in the main interface of setting, then click [Transmission] to save the parameters on the controller.

Attn: For abnormal wiring, the file should be placed under the root directory of software installation.

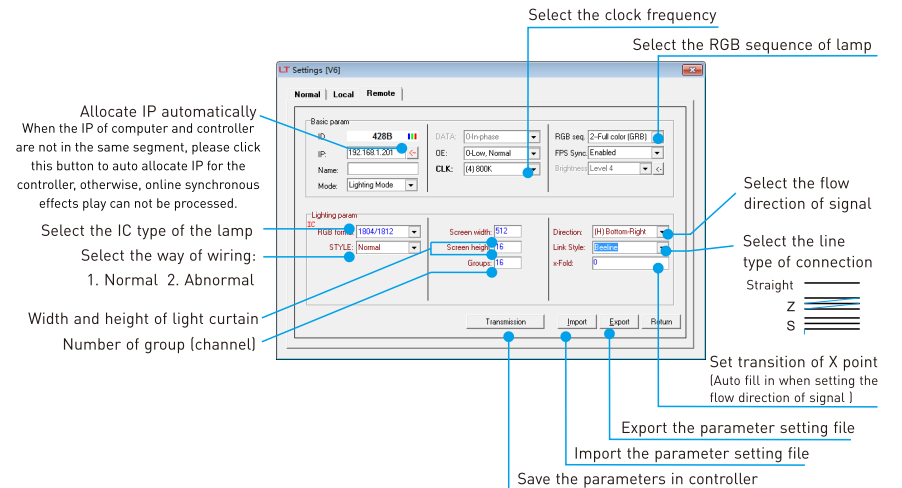

Main interface of setting

If the signal is DMX512, please select it in the [RGB format].

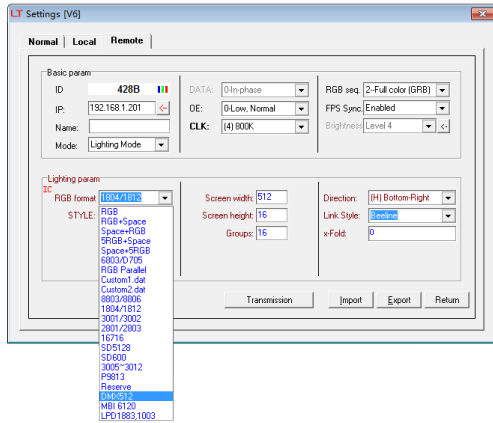

9.1.4 Fill in controller

After setting the correct parameters , click [return] button on the main interface of setting interface to the search interface, click [search] button, then select [fill in controller 1 #] on the right-click menu of the listed controller, enter "Computer parameter setting" interface.

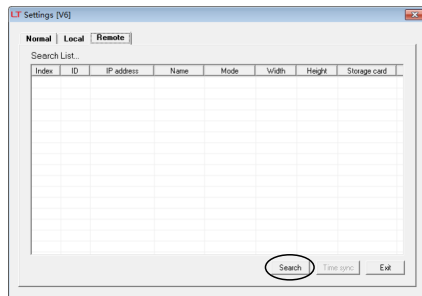

Search controller

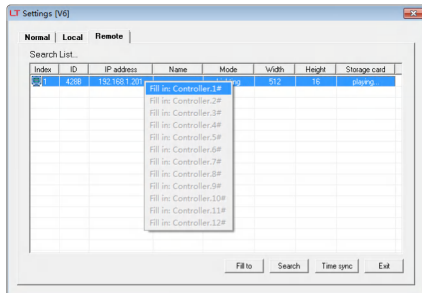

Fill in controller

9.1.5 Save computer parameter setting

Click [save] button on the [computer-setting] and then close the window.

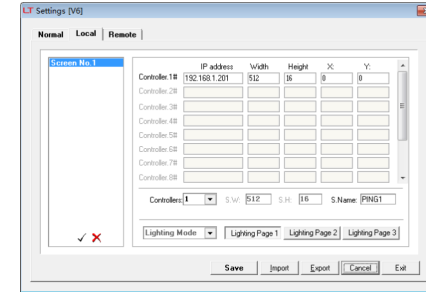

Computer parameter setting

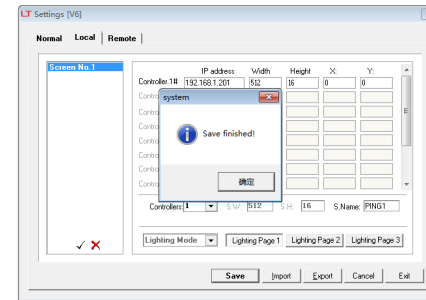

Save the parameter of computer setting

9.2 Play program:

9.2.1 Online synchronous mode

Click [Control] menu and choose [switch to - synchronous mode], under this mode, computer and controller play flashes, pictures, videos, and skipping subtitles synchronously.

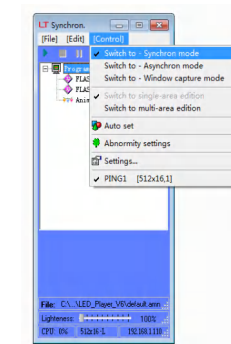

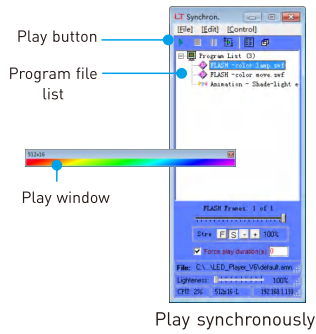

Play synchronously

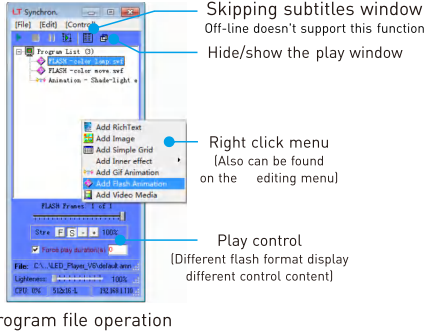

Program file operation

9.2.2 Windows capture mode

Click [Control] menu, and select [switch to-Windows capture Mode]. Under this mode, it can real-time capture the flash effect on the computer desktop and the controller play synchronously.

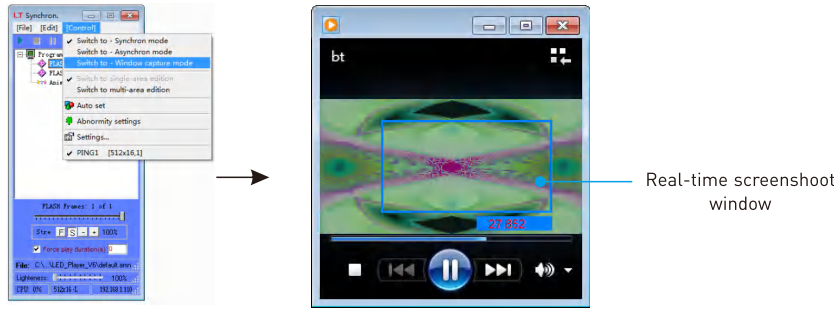

Switch to window capture mode

In process of capturing the flash effect

9.2.3 Off-line asynchronous mode

A. Click [Control] menu and select [Switch to-Asynchronous mode], reach asynchronous mode interface

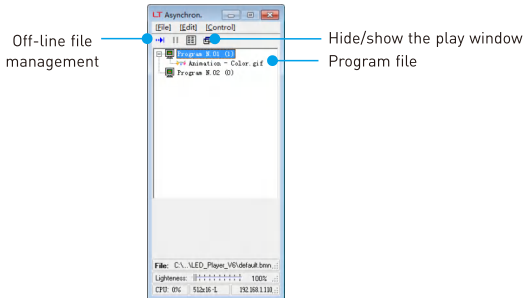
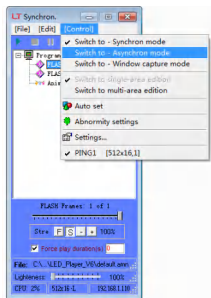

Off-line asynchronous mode

B. Click [Edit] menu and select [Append new program], which can append 14 sets of programs; click [Add Flash Animator] or other program files to add more files on existing program.

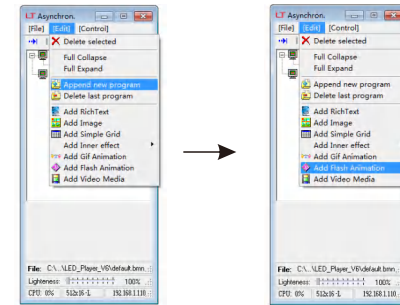

Append new program

Add more program files

C. Click [Off-line file management], pop up [program manager] interface.

a. Recording programs

Click [REC] to generate offline file, and click [Build set. dat] after the completion of all the program recording. Finally, it generates offline configuration file.

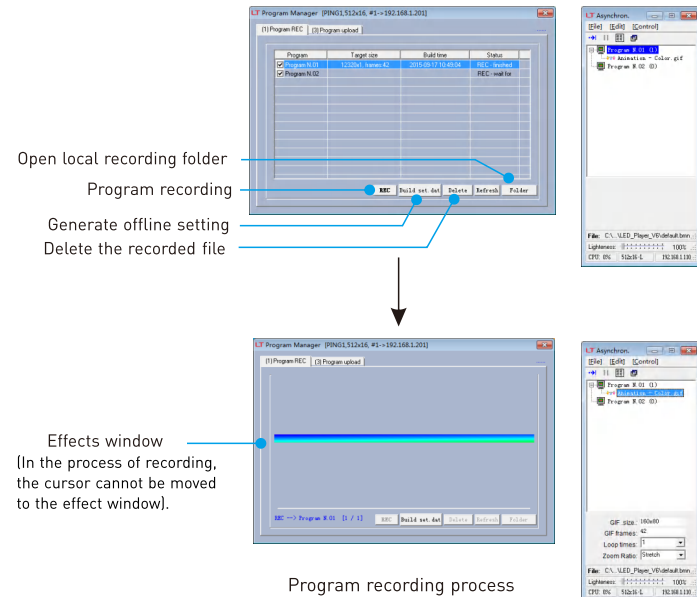

Open local recording folder

Program recording

Generate offline setting

Delete the recorded file

Effects window
(In the process of recording, the cursor cannot be moved to the effect window).

Program recording process

b. Timing

If you need timing offline playback, please click the tab [program scheme] to timing setting interface. Click [Append] or [Modify] to set timing, finally click [Build].

Timing effect as follows: The first set program playback on Monday 6:00-00:00, the second set program playback on Saturday 6:00-00:00, the third set program playback on Sunday 6:00-00:00.

Open the [program scheme] tab

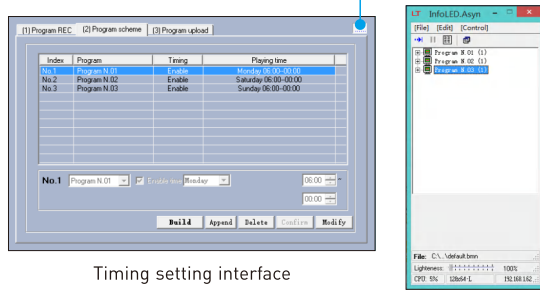

Timing setting interface

c. Play file transmission:

Click [upload], system began to upload the play file and other files to the SD card

Attn: if the Play file is bigger, such as video files generated large files, you can click [Program REC] TAB to open the program recording interface, and then click [folder], all files under the directory will copy into SD with the card reader.

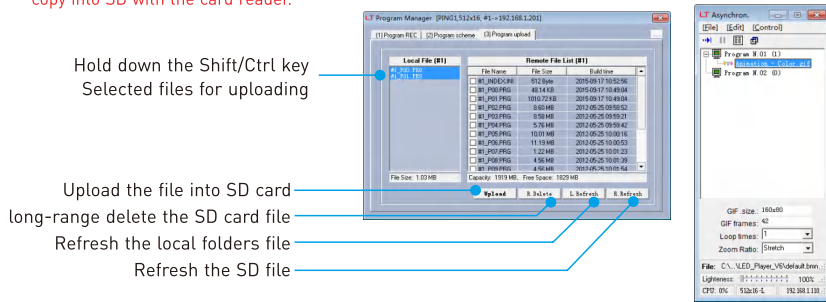

Offline playback can be started immediately after the completion of play file transfer

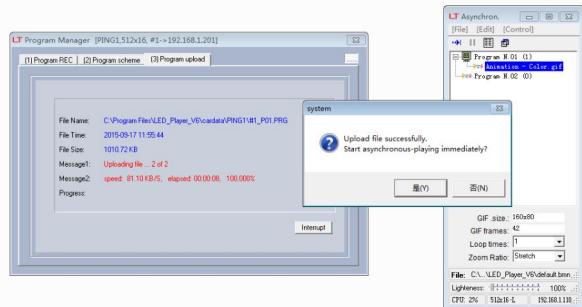

10. Wiring Diagram:

10.1 Connection with tube:

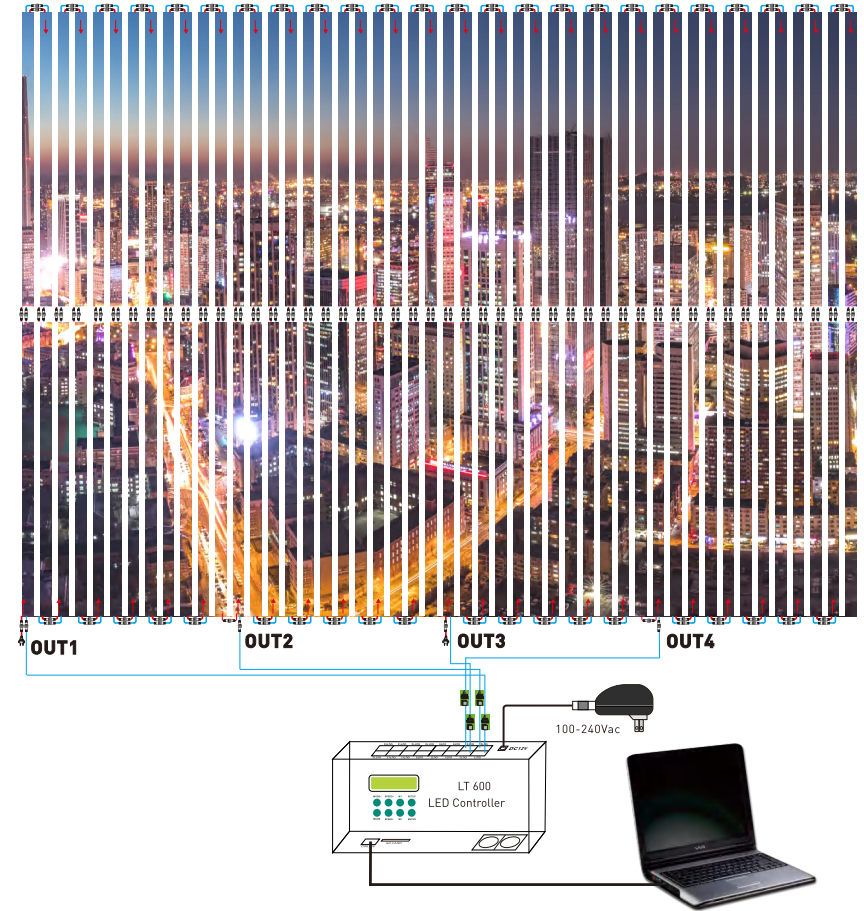

10.2 Connection with computer:

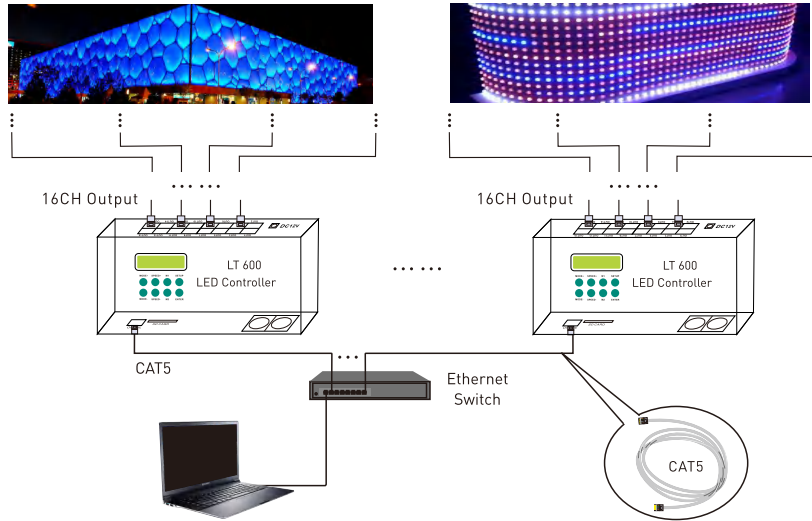

* Real-time computer playback.

10.3 Offline:

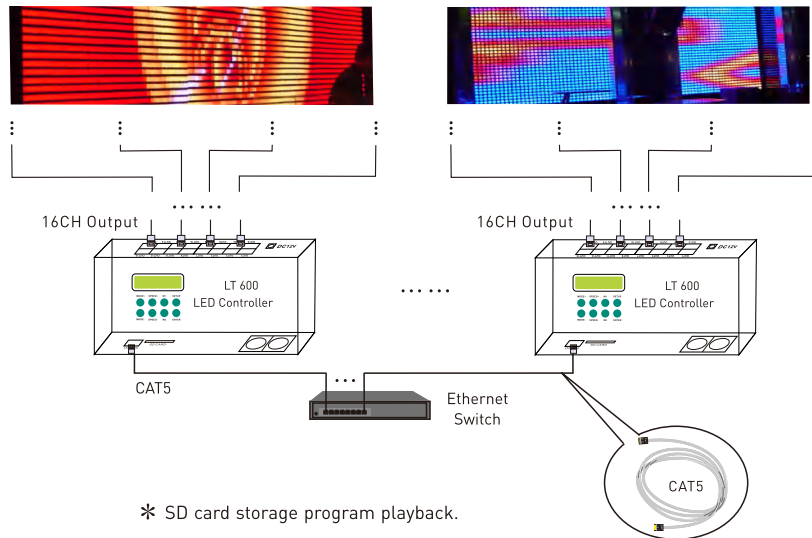

* SD card storage program playback.

10.4 Connection with DMX Console:

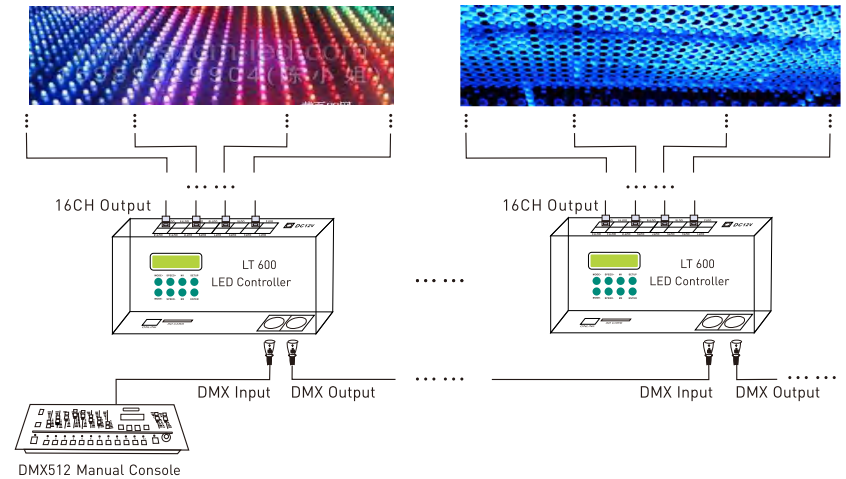

* DMX console selects the program of controller SD card and controls speed.

11. Attention:

1. Products shall be installed by qualified professionals.
2. LTECH products are non-waterproof (special models excepted). Please avoid the sun and rain. When installed outdoors, please ensure it is mounted in a water proof enclosure.
3. Good heat dissipation will extend the working life of products. Please ensure good ventilation.
4. Please check if the working voltage used complies with the parameter requirements of products.
5. The diameter of wire used must be able to load the light fixtures you connect and ensure the firm wiring.
6. Before you power on products, please make sure all the wiring is correct in case of incorrect connection that causes damage to light fixtures.
7. If a fault occurs, please do not attempt to fix products by yourself. If you have any question, please contact your suppliers.

12. Warranty Agreement:

- Warranty periods from the date of delivery 5 years.
- Free repair or replacement services for quality problems are provided within warranty periods.

Warranty exclusions below:

- Beyond warranty periods.
- Any artificial damage caused by high voltage, overload, or improper operations.
- Products with severe physical damage.
- Damage caused by natural disasters and force majeure.
- Warranty labels and barcodes have been damaged.
- No any contract signed by LTECH.

1. Repair or replacement provided is the only remedy for customers. LTECH is not liable for any incidental or consequential damage unless it is within the law.
2. LTECH has the right to amend or adjust the terms of this warranty, and release in written form shall prevail.